

PBCS 4A / 6A / 10A

EN

ORIGINAL INSTRUCTIONS
BATTERY CHARGER



Table of contents

Notes regarding the operating manual..... 2

Safety 2

Information about the device..... 4

Transport and storage..... 6

Operation 6

Errors and faults..... 9

Maintenance 9

Disposal 9

Notes regarding the operating manual

Symbols

 **Warning of electrical voltage**
This symbol indicates dangers to the life and health of persons due to electrical voltage.

 **Warning of explosive substances**
This symbol indicates dangers to the life and health of persons due to potentially explosive substances.

 **Warning of caustic substances**
This symbol indicates dangers to the life and health of persons due to corrosive substances.

 **Warning**
This signal word indicates a hazard with an average risk level which, if not avoided, can result in serious injury or death.

 **Caution**
This signal word indicates a hazard with a low risk level which, if not avoided, can result in minor or moderate injury.

Note
This signal word indicates important information (e.g. material damage), but does not indicate hazards.

 **Info**
Information marked with this symbol helps you to carry out your tasks quickly and safely.

 **Follow the manual**
Information marked with this symbol indicates that the operating manual must be observed.

 **Wear safety glasses**
Information marked with this symbol indicates that you should wear eye protection.

 **Wear protective gloves**
Information marked with this symbol indicates that you should wear protective gloves.

You can download the current version of the instructions and the EU declaration of conformity via the following link:

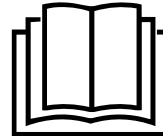

PBCS 4A, PBCS 6A,
PBCS 10A



<https://hub.trotec.com/?id=46744>

Safety

 **Warning**
Read all safety warnings and all instructions.
Failure to follow the warnings and instructions may result in electric shock, fire and/or serious injury.
Save all warnings and instructions for future reference.
This appliance can be used by children aged from 8 years and above and persons with reduced physical, sensory or mental capabilities or lack of experience and knowledge if they have been given supervision or instruction concerning use of the appliance in a safe way and understand the hazards involved.

Children shall not play with the appliance. Cleaning and user maintenance shall not be made by children without supervision.

- Check the device for potential damage before each application. Do not use any defective devices or device parts.
- Never use the device for non-rechargeable batteries.
- Only touch the insulated area of the battery terminals.
- Do not use the device in potentially explosive rooms or areas and do not install it there.
- Do not use the device in aggressive atmosphere.
- Do not immerse the device in water. Do not allow liquids to penetrate into the device.
- Do not use the device with wet or damp hands.

- Do not under any circumstances use the device if you detect damages on the mains plug or power cable. If the power cable is damaged, it must be replaced by the manufacturer, its service agent or similarly qualified persons in order to avoid a hazard. Defective power cables pose a serious health risk!
- This appliance is not a toy. Keep away from children and animals.
- Do not open the device.
- When operating the device, observe the polarity. In the case of reverse polarity, the reverse polarity protection function stops the charging process from being started, in order to prevent damage to the charger and battery.
- Interrupt the charging process if the battery gets too hot. For the maximum temperature, please refer to the manufacturer specifications in the vehicle's operating manual.

Safety warnings on the device

The following safety instructions are additionally attached to the device:

- Read all safety warnings and all instructions.
- Using the device may produce explosive oxyhydrogen gas. Only operate the device in rooms that are well ventilated and prevent open fire and spark formation.
- Always remove the mains plug from the mains socket before attaching or removing the battery terminals.
- Do not expose the charger to rain or wet conditions.

Note regarding automatic charging

The device is provided with a microprocessor control, allowing for automatic monitoring and adaptation of the multi-stage charging cycle. This makes monitoring of the charging process indispensable. Nevertheless we advise you not to leave the battery unattended over a longer period, so that you will be able to disconnect the device manually from the power supply in the event of a fault.

Intended use

This device is designed for charging batteries used in vehicles. This refers to both non-maintenance-free and maintenance-free 12 V batteries, including wet batteries like for instance lead acid, Ca/Ca and EFB batteries as well as lead gel and AGM batteries.

The device is provided with a reconditioning mode which serves to recover the charging capacity of deeply discharged lead acid batteries (however, not AGM and GEL). This function may only be used briefly and under supervision.

By means of the supply mode, the device can be used for buffer power supply, e.g. during a battery change.

Furthermore, the device features a trickle charging mode which can be used additionally as a charging function for batteries with a low battery capacity.

The device is suitable for indoor use as well as for outdoor areas protected from weather conditions.

The device is only intended for private, non-commercial use.

Foreseeable misuse

The device must not be used for charging lithium iron phosphate batteries (e.g. LiFePO₄) or other rechargeable lithium batteries.

The device must not be used to charge non-rechargeable batteries.

The device is only intended for mobile use and not for the installation in caravans, camper vans or similar vehicles.

Personnel qualifications

People who use this device must:

- have sufficient proficiency in the field of electrics and utilise the device performing safe working practices.
- have read and understood the operating manual, especially the Safety chapter.

Personal protective equipment



Wear safety glasses

Wear suitable protective goggles when using the device.



Wear protective gloves

Wear suitable protective gloves when using the device.

Residual risks



Warning

Explosion hazard!

Using the device may produce explosive gas. Prevent spark formation that is caused for instance by smoking and open fire. Ensure sufficient ventilation.



Warning of caustic substances

The acid contained in the battery is corrosive. Rinse out acid splashes thoroughly immediately with plenty of water and consult a doctor in case of an emergency.



Warning of electrical voltage

Electric shock due to lightning strike.

Do not work outdoors in case of approaching thunderstorms.

In case of a thunderstorm, disconnect the device from the mains.

The operator is responsible for the lightning protection of the building.



Warning of electrical voltage

Electric shock due to insufficient insulation!

Check the device for damages and proper functioning before each use.

If you detect damages, do not use the device any longer. Do not use the device when either the device or your hands are damp or wet!



Warning of electrical voltage

Before any work on the device, remove the mains plug from the mains socket!

Do not touch the mains plug with wet or damp hands. Hold onto the mains plug while pulling the power cable out of the mains socket.



Warning of electrical voltage

Work on the electrical components must only be carried out by an authorised specialist company!



Caution

Keep a sufficient distance from heat sources.

Note

To prevent damages to the device, do not expose it to extreme temperatures, extreme humidity or moisture.

Note

Do not use abrasive cleaners or solvents to clean the device.

Information about the device

Device description

The device serves to charge various battery types of vehicles.

The device charges the battery by transporting mains current into the battery via a charging cable. A second charging cable is attached for the purpose of earthing on one of the points specified in the vehicle's instructions.

The microprocessor control ensures that the multi-stage charging process is monitored and adapted automatically.

In the *winter charging mode*, the battery can be charged at an outdoor temperature of -20 °C to +5 °C.

In the *trickle charging mode*, the battery can be protected against deep discharge and maintained at a permanently ideal charging level, e.g. for seasonally used vehicles with long downtimes.

In the *supply mode*, the power supply of a vehicle can be bridged, e.g. in the case of a battery change.

In the *reconditioning mode*, deeply discharged batteries can be reconditioned.

The device features IP65 type of protection and is dust-tight and protected against water jets.

The device is provided with protective mechanisms protecting the charger and battery, including reverse polarity protection and protection against short circuits.

Fully insulated battery terminals and a suspension eye for wall mounting provide for safe and convenient use.

Scope of delivery

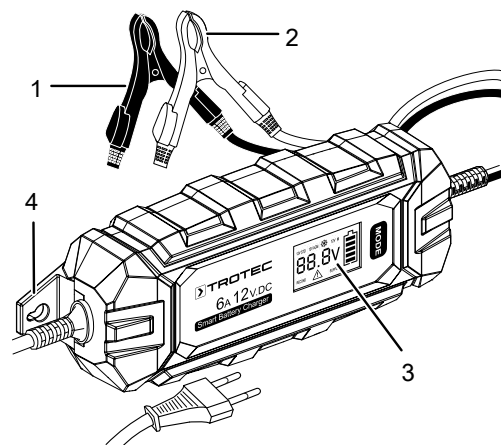

- 1 x Battery charger
- 1 x Manual

Device depiction



No.	Designation
1	Black battery terminal (-)
2	Red battery terminal (+)
3	Control panel
4	Suspension eye

Technical data

Parameter	Value		
	PBCS 4 A	PBCS 6 A	PBCS 10 A
Model	PBCS 4 A	PBCS 6 A	PBCS 10 A
Mains voltage	220 – 240 V / ~ 50 Hz		
Rated input power	70 W	100 W	160 W
Nominal output voltage	12 V DC		
Fusing 	3.15 A (slow-blowing)		
Protection class	II / 		
Type of protection	IP65		
Ambient temperature	-20 °C to +40 °C		
Battery capacity Standard charging mode, AGM winter charging mode	4 - 120 Ah	4 - 150 Ah	4 - 200 Ah
Battery capacity Trickle charging mode (max. 1 A for PBCS 4A, PBCS 6A) (max. 2 A for PBCS 10A)	2 - 32 Ah	2 - 32 Ah	3 - 60 Ah
Length of the supply line	150 cm		
Length of charging cable	155 cm		
Plug type	CEE 7/16		
Dimensions (length x width x height)	227 mm x 90 mm x 50 mm	280 mm x 105 mm x 62 mm	280 mm x 105 mm x 62 mm
Weight	0.47 kg	0.65 kg	0.76 kg
Charging time (for 80 %)	2 h with 8 Ah	2 h with 12 Ah	2 h with 20 Ah
	5 h with 20 Ah	5 h with 30 Ah	5 h with 50 Ah
	10 h with 40 Ah	10 h with 60 Ah	10 h with 100 Ah
	20 h with 80 Ah	20 h with 120 Ah	18 h with 180 Ah

Charging end voltage and nominal output current









Charging mode	Charging end voltage	Nominal output current		
		PBCS 4 A	PBCS 6 A	PBCS 10 A
Standard	14.2 V	4 A	6 A	10 A
AGM	14.6 V	4 A	6 A	10 A
Winter	14.8 V	4 A	6 A	10 A
Trickle charging	14.2 V	1 A	1 A	2 A
Reconditioning	15.3 V	1.5 A	1.5 A	2.5 A
Supply	13.7 V	3 A	5 A	8 A

Field of application

The models that will be required from our range of chargers in each case depend on the type of vehicle.

This operating manual applies to the PBCS 4A, PBCS 6A, PBCS 10A models.

The following table provides you with an overview of the models suitable for the respective vehicle types.

Approximate charging time	PBCS 2A	PBCS 4A	PBCS 6A	PBCS 10A	Common battery size
	++ 2 h	+	+	-	4 Ah
	++ 6 h	++ 3 h	+	-	12 Ah
	++ 9 h	++ 5 h	++ 3 h	-	18 Ah
	+	++ 11 h	++ 8 h	+	45 Ah
	--	++ 18 h	++ 12 h	++ 7 h	70 Ah
	--	+	++ 17 h	++ 10 h	100 Ah
	--	-	+	++ 12 h	120 Ah
	--	--	+	++ 15 h	145 Ah
	--	--	--	++ 18 h	180 Ah

Icon	Meaning
++	The device is well suited for this vehicle type.
+	The device is suited for this vehicle type.
-	The device is less suited for this vehicle type.
--	The device is not suited for this vehicle type.

Transport and storage

Note

If you store or transport the device improperly, the device may be damaged.
 Note the information regarding transport and storage of the device.

Transport

Before transporting the device, observe the following:

- Hold onto the mains plug while pulling the power cable out of the mains socket.
- Do not use the power cable to drag the device.

Storage

- Store the device in a dry location and protected from frost and heat.
- Store the device in a location where it is protected from dust and direct sunlight.

Operation

Preparing the charging process



Warning of electrical voltage

Electric shock due to insufficient insulation!
 Check the device for damages and proper functioning before each use.
 If you detect damages, do not use the device any longer.
 Do not use the device when either the device or your hands are damp or wet!



Warning

Explosion hazard! Never charge frozen batteries or batteries with a temperature of more than 45 °C.



Warning of caustic substances

The acid contained in the battery is corrosive. Rinse out acid splashes thoroughly and immediately with plenty of water and consult a doctor in case of an emergency.
 Wear protective goggles and suitable protective gloves.



Unpacking the device

1. Take the device out of the packaging.
2. Check the content for damage.
3. Dispose of the packaging material according to the national regulations.

Control panel

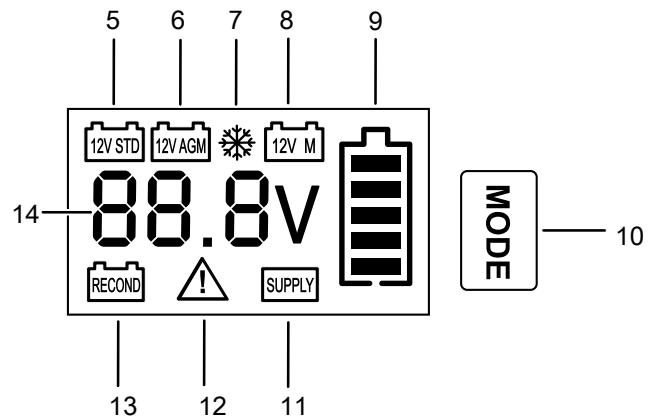

No.	Designation	Meaning
5	Standard charging mode symbol	Is displayed when the standard charging mode is activated
6	AGM charging mode symbol	Is displayed when the charging mode for AGM batteries is activated.
7	Winter charging mode symbol	Is displayed when the winter charging mode is activated.
8	Trickle charging mode symbol	Is displayed when the trickle charging mode is activated.
9	Charging level symbol	Charging level and charging process of the battery (20 % per graduation mark) <ul style="list-style-type: none"> • Graduation mark is shown continuously: Battery has reached the charging level • Graduation mark flashing: Battery is charged to the next charging level • All graduation marks are shown: Battery is fully charged
10	Mode button	Setting the desired charging mode
11	Supply mode symbol	Is displayed when the supply mode is activated.
12	Error symbol	Is displayed when an error is pending: <ul style="list-style-type: none"> • Incorrect battery voltage (< 3.5 V or > 15 V) • Terminals connected with reverse polarity • Short circuit Flashes if there is a short circuit while the supply mode is active
13	Reconditioning mode symbol	Is displayed when the reconditioning mode is activated.
14	Status display	<ul style="list-style-type: none"> • Charging voltage in volts • bAt: Defect on the battery • FUL: Fully charged • Err: Incorrect polarity or short circuit • Lo V: Battery voltage below 3.5 V or short circuit while supply mode is active

Setting the charging mode

Select the desired charging mode by pressing the Mode button (10) until the corresponding symbol is shown on the control panel.

Standard charging mode

The standard charging mode is suitable for all 12 V batteries of the lead acid and GEL type.

AGM charging mode

The AGM charging mode is specifically suited for charging 12 V batteries of the AGM type.

Winter charging mode

In the winter charging mode, 12 V batteries of the lead acid, AGM and GEL type can be charged at an ambient temperature of -20 °C to +5 °C.

Trickle charging mode

In the trickle charging mode, the maximum charging current flowing is 1 A (2 A with the PBCS 10 A model). The trickle charging mode has the following modes of operation:

- Charging of 12 V batteries of the lead acid, AGM and GEL type with a low charging capacity.
- Trickle charge of a 12 V battery of the lead acid, AGM and GEL type as protection against deep discharge. The battery is continuously maintained at a capacity of 95 - 100 % by means of pulse charging.

Reconditioning mode

Note

The reconditioning mode can only be used for lead acid batteries. Never use the reconditioning mode for batteries with a closed design (e.g. GEL or AGM).

Note

The reconditioning mode may only be used for free-standing, dismantled batteries. Do not use the reconditioning mode whilst the battery is built in and is connected to the vehicle's on-board electronics. They may be damaged by the increased charging voltage.

1. Press and hold the Mode button (10) for 5 seconds to activate the reconditioning mode.
2. Monitor the process at least every 30 minutes.
3. Remove the device as described in the *Completing the charging process* section as soon as the battery audibly emits gas (bubbling noise), however, after 4 hours at the latest.

Supply mode

Press the Mode button (10) again if you wish to switch from the reconditioning mode to the supply mode.

Press and hold the Mode button (10) again for 5 seconds to change back to the charging programs (5 - 8).

Charging process



Warning

Never use these devices to charge non-rechargeable batteries. Only charge battery types that are indicated in the chapter "Intended use".

As a rule, the battery should be charged when removed.

If it is not possible to remove the battery, it can remain inside the vehicle during the charging process. Note that most vehicles have a negative grounding. The negative terminal of the battery is connected to the car body.

In rare cases, however, there may be a positive grounding where the positive terminal of the battery is connected to the car body.

For this reason, observe the information on earthing in the vehicle instructions before using the charger.

Charging process when removed

1. Clamp the red cable (2) to the positive terminal of the battery.
2. Clamp the black cable (1) to the negative terminal of the battery.
3. Plug the mains plug of the charger into the mains socket.
4. Select the desired charging mode as described in the *Setting the charging mode* section.
 - ⇒ The charging process is completed when the status indication (14) shows "FUL". Afterwards, the charger maintains the battery at a battery capacity of 95 - 100 % by means of pulse charging.
5. Check the terminal posts of the battery for dirt and corrosion and, if necessary, clean them as described in the manufacturer specifications.
6. Reinstall the charged battery in accordance with the vehicle instructions.

Note

If the battery is fully charged after just a few minutes, the battery capacity presumably is low. In this case, the battery should be replaced.

Charging with negative grounding

1. Switch off all electrical loads.

Note

Take into account that any active loads will yet delay the charging process when the battery remains installed during the process.

2. Clamp the red cable (2) to the positive terminal of the battery.
3. Clamp the black cable (1) to the car body, observing the vehicle instructions and keeping a distance from the battery and fuel line.
4. Plug the mains plug of the charger into the mains socket.
5. Select the desired charging mode as described in the *Setting the charging mode* section.

⇒ The charging process is completed when the status indication (14) shows "FUL". Afterwards, the charger maintains the battery at a battery capacity of 95 - 100 % by means of pulse charging.

Note

If the battery is fully charged after just a few minutes, the battery capacity presumably is low. In this case, the battery should be replaced.

Charging with positive grounding

1. Switch off all electrical loads.

Note

Take into account that any active loads will yet delay the charging process when the battery remains installed during the process.

2. Clamp the black cable (1) to the negative terminal of the battery.
3. Clamp the red cable (2) to the car body, observing the vehicle instructions and keeping a distance from the battery and fuel line.
4. Plug the mains plug of the charger into the mains socket.
5. Select the desired charging mode as described in the *Setting the charging mode* section.

⇒ The charging process is completed when the status indication (14) shows "FUL". Afterwards, the charger maintains the battery at a battery capacity of 95 - 100 % by means of pulse charging.

Note

If the battery is fully charged after just a few minutes, the battery capacity presumably is low. In this case, the battery should be replaced.

Calculating the charging time

Normally the duration of the charging process depends on the previous charging level of the battery. The charging time required to charge an empty battery to up to approx. 80 % can be calculated as follows:

Charging time (h) = battery capacity in Ah ÷ charging current in Amp.

For more information on this, please also refer to the table in the *Field of application* section.

Note

If the battery is fully charged after just a few minutes, the battery capacity presumably is very low. In this case, the battery should be replaced.

Errors and faults

The device has been checked for proper functioning several times during production. If malfunctions occur nonetheless, check the device according to the following list.

The device is not charging:

- Make sure that the power plug is inserted and the power supply is working.

The device is switched on and the Error display (12) is illuminated:

- Check whether the charging clips are connected correctly. Otherwise, the reverse polarity protection function prevents the charging process from being started, ensuring that the charger and battery are not damaged.

Note

When the supply mode is used, automatic polarity reversal protection is not provided.

- Make sure that the charging clips are not in contact with each other. In the event of a short circuit, the short circuit protection function ensures that the charger will not be damaged.
- If the polarity is reversed or a short circuit occurs, "Err" is shown on the control panel.
- In the event of an insufficient battery voltage (< 3.5 V) or a short circuit in supply mode, "Lo V" is indicated on the control panel.
- Make sure that the battery is suited for charging, since the battery type is not recognised automatically. A voltage of less than 3.5 V or more than 15 V can cause a fault indication.
- Check whether the battery to be charged is defective and refer to suitable specialised personnel, if necessary.
- If a battery is defective or not suitable, "bAt" is shown on the control panel.

Maintenance

Cleaning

Clean the device with a soft, damp and lint-free cloth. Ensure that no moisture enters the housing. Protect electrical components from moisture. Do not use any aggressive cleaning agents such as cleaning sprays, solvents, alcohol-based or abrasive cleaners to dampen the cloth.

Wipe the housing dry after cleaning.

Clear the device terminals from dirt and corrosion.

Repair

Do not modify the device or install any spare parts. For repairs or device testing, contact the manufacturer.

Disposal

Always dispose of packing materials in an environmentally friendly manner and in accordance with the applicable local disposal regulations.



The icon with the crossed-out waste bin on waste electrical or electronic equipment is taken from Directive 2012/19/EU. It states that this device must not be disposed of with the household waste at the end of its life. You will find collection points for free return of waste electrical and electronic equipment in your vicinity. The addresses can be obtained from your municipality or local administration. You can also find out about other return options that apply for many EU countries on the website <https://hub.trotec.com/?id=45090>. Otherwise, please contact an official recycling centre for electronic and electrical equipment authorised for your country.

The separate collection of waste electrical and electronic equipment aims to enable the re-use, recycling and other forms of recovery of waste equipment as well as to prevent negative effects for the environment and human health caused by the disposal of hazardous substances potentially contained in the equipment.

Only for United Kingdom

According to Waste Electrical and Electronic Equipment Regulations 2013 (SI 2013/3113) (as amended) devices that are no longer usable must be collected separately and disposed of in an environmentally friendly manner.

Trotec GmbH

Grebener Str. 7
D-52525 Heinsberg

☎ +49 2452 962-400

☎ +49 2452 962-200

✉ info@trotec.com

www.trotec.com