

EN

INSTRUCTIONS
MATERIAL MOISTURE
MEASURING DEVICE
CONTROLLED VIA SMARTPHONE



Table of contents

Information on the use of these instructions 2

Safety 2

Information about the device 4

Transport and storage 5

Operation 5

Measuring principle 16

Maintenance and repair 17

Errors and faults 18

Disposal 18

Declaration of conformity 19

Information on the use of these instructions

Symbols



Warning of electrical voltage

This symbol indicates dangers to the life and health of persons due to electrical voltage.



Warning

This signal word indicates a hazard with an average risk level which, if not avoided, can result in serious injury or death.



Caution

This signal word indicates a hazard with a low risk level which, if not avoided, can result in minor or moderate injury.

Notice

This signal word indicates important information (e.g. material damage), but does not indicate hazards.



Info

Information marked with this symbol helps you to carry out your tasks quickly and safely.



Follow the manual

Information marked with this symbol indicates that the instructions must be observed.

You can download the current version of the instructions and the EU declaration of conformity via the following link:



BM22WP



<https://hub.trotec.com/?id=43339>

Safety

Read this manual carefully before starting or using the device. Always store the manual in the immediate vicinity of the device or its site of use.



Warning

Read all safety warnings and all instructions.

Failure to follow the warnings and instructions may result in electric shock, fire and/or serious injury.

Save all warnings and instructions for future reference.

- Do not use the device in potentially explosive rooms or areas and do not install it there.
- Do not use the device in an aggressive atmosphere.
- Do not immerse the device in water. Do not allow liquids to penetrate into the device.
- The device may only be used in dry surroundings and must not be used in the rain or at a relative humidity exceeding the operating conditions.
- Protect the device from permanent direct sunlight.
- Do not expose the device to strong vibrations.
- Do not open the device.
- Do not remove any safety signs, stickers or labels from the device. Keep all safety signs, stickers and labels in legible condition.
- Never charge batteries that cannot be recharged.
- Different types of batteries and new and used batteries must not be used together.
- Insert the batteries into the battery compartment according to the correct polarity.
- Remove discharged batteries. Batteries contain materials hazardous to the environment. Dispose of the batteries according to the national regulations.
- Remove the batteries from the device if you will not be using the device for a longer period of time.
- Never short-circuit the supply terminal in the battery compartment!

- Do not swallow batteries! If a battery is swallowed, it can cause severe internal burns within 2 hours! These burns can lead to death!
- If you think batteries might have been swallowed or otherwise entered the body, seek medical attention immediately!
- Keep new and used batteries and an open battery compartment away from children.
- Observe the storage and operating conditions (see Technical data).

Intended use

Use this device in combination with a terminal device that is compatible with the installed Trotec MultiMeasure Mobile app. Only use the device for moisture measurements of wood and building materials within the measuring range specified in the technical data.

The Trotec MultiMeasure Mobile app on the terminal device is used for both operation and the evaluation of the measured values.

Data logged by the device can be displayed, saved or transmitted either numerically or in form of a chart.

To use the device for its intended use, only use accessories and spare parts which have been approved by Trotec.

Any use other than the intended use is regarded as misuse.

Reasonably foreseeable misuse

Do not use the device in potentially explosive atmospheres, for measurements in liquids or on live parts.

Radio waves may interfere with the operation of medical equipment and cause malfunctions. Do not use the device near medical equipment or within medical institutions.

Persons with pacemakers must observe a minimum distance of 20 cm between the pacemaker and the device.

Also do not use the device near automatically controlled systems such as alarm systems and automatic doors. Radio waves may interfere with the operation of such equipment and cause malfunctions. Make sure that no other devices are malfunctioning during the use of your device.

Any unauthorised changes, modifications or alterations to the device are forbidden.

Personnel qualification

People who use this device must:

- have read and understood the instructions, especially the Safety chapter.

Residual risks



Warning of electrical voltage

There is a risk of a short-circuit due to liquids penetrating the housing!

Do not immerse the device and the accessories in water. Make sure that no water or other liquids can enter the housing.



Warning of electrical voltage

Work on the electrical components must only be carried out by an authorised specialist company!



Warning

Risk of suffocation!

Do not leave the packaging lying around. Children may use it as a dangerous toy.



Warning

The device is not a toy and does not belong in the hands of children.



Warning

Dangers can occur at the device when it is used by untrained people in an unprofessional or improper way! Observe the personnel qualifications!



Caution

When handling the device there is a risk of injury due to the exposed measuring tips.

Always put on the protective cap when not in use.



Caution

Keep a sufficient distance from heat sources.

Notice

Exclusively use the original measuring tips included in the scope of delivery. Other measuring tips might bend or damage the holder at the measuring device.

Notice

Never force the measuring device into the material to be measured or yank it out. Applying force can lead to bending or breaking of the measuring tips or to the destruction of the housing.

Notice

To prevent damages to the device, do not expose it to extreme temperatures, extreme humidity or moisture.

Notice

Do not use abrasive cleaners or solvents to clean the device.

Information about the device

Device description

Used in combination with Trotec's MultiMeasure Mobile app the material moisture measuring device permits material moisture measurements of wood, plaster, brick, cement mortar, cement screed and concrete.

In case of individual measurements, the measurement value display can be refreshed both via the app and by a brief actuation of the measurement button at the measuring device.

Apart from the hold function, the measuring device can indicate minimum, maximum and average values and carry out series measurements.

In the app you can specify MAX and MIN alarm thresholds for all parameters measured with the device.

In case of a matrix measurement the measured values can be displayed two-dimensionally (XY-diagram) with a background image or grid.

The measurement results can be displayed and saved on the terminal device either numerically or in form of a chart. Then, the measurement data can be sent in PDF or Excel format.

The app also includes a report generation function, an organiser function, one for customer management and further analysis options. Moreover, it is possible to share measurements and project data with colleagues in another subsidiary.

If MultiMeasure Studio Professional is installed on a PC, you can even use report templates and ready-made text blocks for various fields of application to turn the data into professional reports.

Device depiction

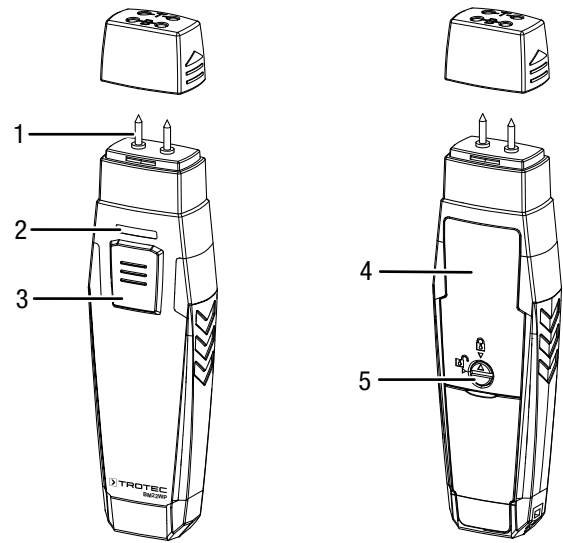

No.	Designation
1	Measuring sensor
2	LED
3	<i>On / off / measurement</i> button
4	Battery compartment with cover
5	Lock

Technical data

Parameter	Value
Model	BM22WP
Measurement principle	resistance measuring method
Electrode length	approx. 8 mm
Electrodes	replaceable
Wood moisture	
Measuring range	6 to 26 %
Accuracy	± 2 %
Resolution	1 %
Building moisture	
Measuring range	Plaster: 0.2 to 2.4 %
	Brick: 1.0 to 5.5 %
	Cement mortar: 1.5 to 7.7 %
	Cement screed: 4.7 to 9.0 %
	Concrete: 3.9 to 7.0 %
Accuracy	± 0.2 %
Resolution	0.05 %
General technical data	
Bluetooth standard	Bluetooth 4.0, Low Energy
Bluetooth frequency range	2.4 GHz
Bluetooth max. transmission power	10 dBm
Radio range	approx. 10 m (depending on measuring environment)
Storage temperature	-10 °C to 60 °C with < 90 % RH non-condensing
Operating temperature	0 °C to 50 °C with < 80 % RH
Power supply	3 x 1.5 V batteries, type AAA
Device switch-off	after approx. 3 minutes without active Bluetooth connection
Protection type	IP40
Weight	103 g
Dimensions (length x width x height)	22 mm x 33 mm x 140 mm (incl. protective cap)

Scope of delivery

- 1 x Device BM22WP (without batteries)
- 1 x Wrist strap
- 1 x Quick guide

Transport and storage

Notice

If you store or transport the device improperly, the device may be damaged.

Note the information regarding transport and storage of the device.

Transport

When transporting the device, ensure dry conditions and protect the device from external influences e.g. by using a suitable bag.

Storage

When the device is not being used, observe the following storage conditions:

- dry and protected from frost and heat
- protected from dust and direct sunlight
- the storage temperature complies with the values specified in the Technical data
- Batteries are removed from the device

Operation

Inserting the batteries

Notice

Make sure that the surface of the device is dry and the device is switched off.

1. Unlock the battery compartment by turning the lock (5) in a way that the arrow points towards the opened padlock icon.
2. Remove the cover from the battery compartment (4).
3. Insert the batteries (3 batteries of type AAA) into the battery compartment with correct polarity.
4. Put the cover back onto the battery compartment.
5. Lock the battery compartment by turning the lock (5) in a way that the arrow points towards the closed padlock icon.

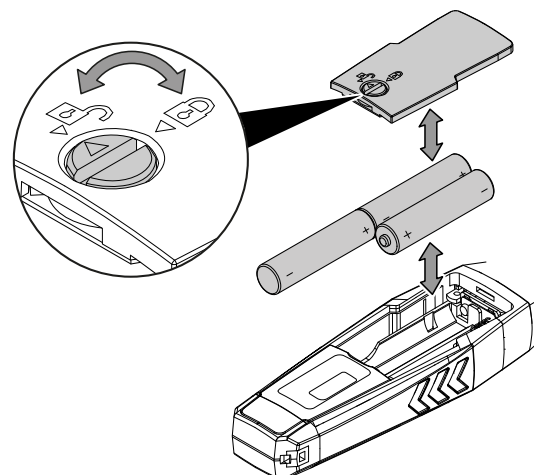

MultiMeasure Mobile app



Install the Trotec MultiMeasure Mobile app on the terminal device you want to use in combination with the device.

Info

Some of the app's functions require access to your location and an active Internet connection.

The app is available for download in the Google Play Store as well as in Apple's app store and via the following link:



<https://hub.trotec.com/?id=43083>

Start-up

Info

Allow for an acclimatization period of about 10 minutes in the respective measuring environment prior to the appSensor's measuring operation.

Proceed as follows to start up the appSensor:

1. Remove the protective cap from the device.
 - ⇒ The measuring tips are revealed and can be used for measurements.

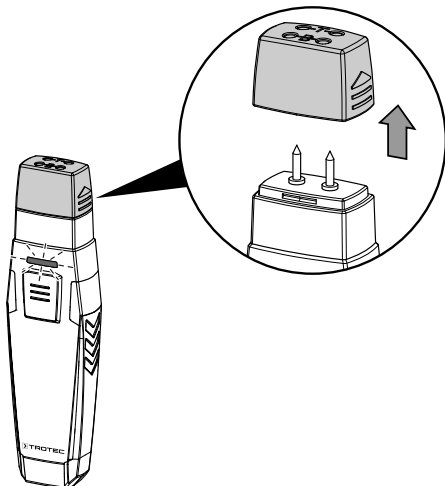

Connecting the appSensor

Info

The app can simultaneously be connected to several different appSensors or appSensors of the same type and also record several measurements at the same time.

Proceed as follows to connect the appSensor to the terminal device:

- ✓ The Trotec MultiMeasure Mobile app is installed.
 - ✓ The Bluetooth function on your terminal device is activated.
1. Start the Trotec MultiMeasure Mobile app on the terminal device.
 2. Briefly actuate the *On / off / measurement* button (3) three times to switch on the appSensor.
 - ⇒ The LED (2) flashes yellow.
 3. Press the *Sensors* button (6) on the terminal device.
 - ⇒ The sensors overview opens.
 4. Press the *Refresh* button (7).
 - ⇒ If the scanning mode was not active before, the colour of the *Refresh* button (7) will change from grey to black. The terminal device now scans the surroundings for all available appSensors.
 5. Press the *Connect* button (8) to connect the desired sensor to the terminal device.
 - ⇒ The LED (2) flashes green.
 - ⇒ The appSensor is connected to the terminal device and starts measuring.
 - ⇒ The on-screen display changes to the continuous measurement.

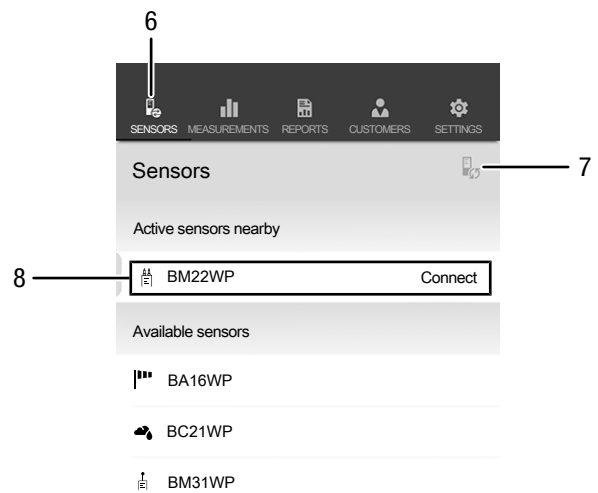

No.	Designation	Meaning
6	<i>Sensors</i> button	Opens the sensors overview
7	<i>Refresh</i> button	Refreshes the list of sensors near the terminal device
8	<i>Connect</i> button	Connects the displayed sensor to the terminal device

Performing a function test

1. Make sure that the app is set to the measuring mode for wood.
 2. Hold the measuring tips to the contacts lettered -T- at the top of the protective cap (device test).
⇒ The display ought to indicate the value 18 % ± 1.
 3. Hold the measuring tips to the contacts lettered -B- at the top of the protective cap (battery test).
⇒ The display ought to indicate the value 26 % ± 1.
- ⇒ If the device reacts as described, the general function test is completed with a positive result.

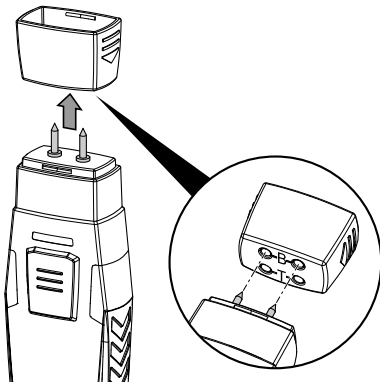

If the device does not react as described, please check the battery voltage or replace the batteries with new ones of high quality. If this does not solve the problem, please contact the Trotec customer service.

Selecting material

Before you carry out a measurement you should select the material to be measured. To do so, please proceed as follows:

1. Press the *Menu* button (11).
⇒ The context menu opens.
2. Press the *Sensor settings* button (15).

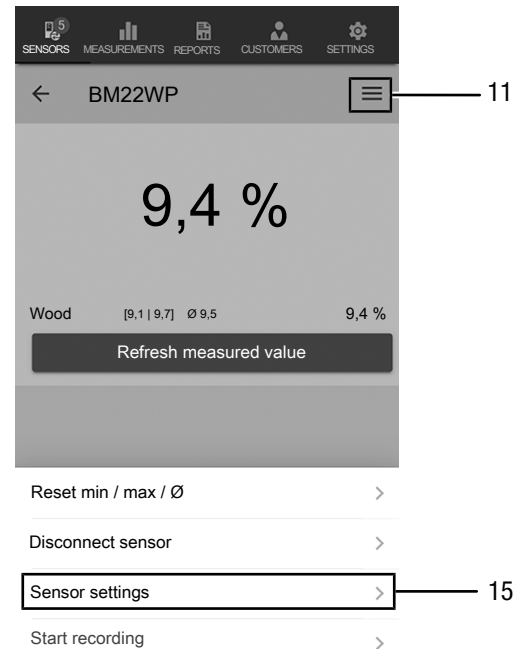

⇒ The sensor settings menu opens.

Via the menu item *Features* you can choose from the following:

- Wood
- Plaster
- Brick
- Cement mortar
- Cement screed
- Concrete

Carrying out a measurement

Put the sensor at a right angle on the material to be measured and press the measuring tips as far as possible into the material to be measured.



Info

Under no circumstances may the measuring tips be driven into the material by means of a hammer! Otherwise the measuring device will be damaged.



Info

Please note that the indicated measured values are merely rough reference values. Since, particularly in case of mineral building materials, the measurement results can be influenced by salinization as well as chemical additives, the determined values shall only be used as an indicator of near-surface material moisture, not for an absolute assessment.



Info

Note that moving from a cold area to a warm area can lead to condensation forming on the device's circuit board. This physical and unavoidable effect can falsify the measurement. In this case, the app will either display incorrect measured values or none at all. Wait a few minutes until the device has become adjusted to the changed conditions before carrying out a measurement.

Individual value measurement

When the appSensor has been successfully connected to the terminal device, an individual value measurement is started and the first determined value will be indicated.

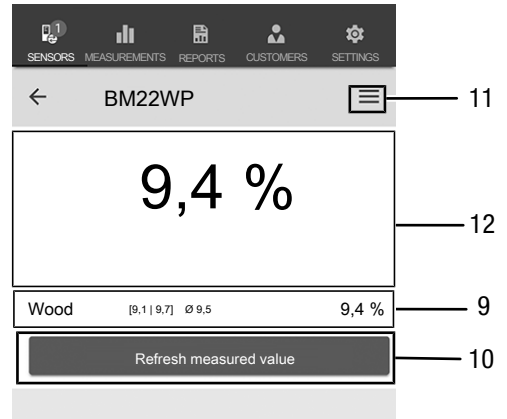

No.	Designation	Meaning
9	Numeric <i>value</i> display	Indicates the minimum, maximum and average values as well as the current moisture value of the selected material in per cent (material selection via sensor settings)
10	<i>Refresh measured value</i> button	Performs an individual measurement and refreshes the displayed values
11	<i>Menu</i> button	Opens the menu to adjust the settings of the current measurement
12	<i>Measured value</i> indication	Indicates the most recently determined value for the selected material in per cent

Refreshing the measured value

Proceed as follows to refresh the measured values in the individual value measurement mode:

1. Press the *Refresh measured value* button (10) on the terminal device.
 - ⇒ The appSensor determines the current measured value which is then displayed on the terminal device.
2. You can also press the *On / off / measurement* button (3) on the appSensor.
 - ⇒ The appSensor determines the current measured value which is then displayed on the terminal device.

Measurement settings

Proceed as follows to adjust the settings for the measurement:

1. Press the *Menu* button (11) or the free area below the measured value display.
⇒ The context menu opens.
2. Adjust the settings as required.

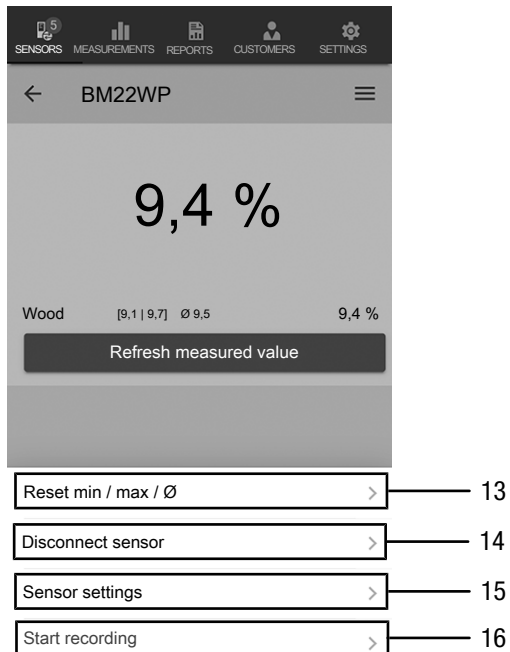

Recording measured values

Proceed as follows to record measured values for later evaluation:

1. Press the *Menu* button (11).
⇒ The context menu opens.
2. Press the *Start recording* button (16).
⇒ A menu listing different measurement methods will be displayed:
 - Individual spot measurement without image
 - Individual spot measurement with image
 - Matrix measurement without background image
 - Matrix measurement with background image

If you select one of the measurement methods, you will be redirected to the respective submenu and the *REC* button (17) will be displayed instead of the *Menu* button (11).

No.	Designation	Meaning
13	<i>Reset min / max / Ø</i> button	Deletes the determined values
14	<i>Disconnect sensor</i> button	Disconnects the connected appSensor from the terminal device
15	<i>Sensor settings</i> button	Opens the settings menu for the connected appSensor
16	<i>Start recording</i> button	Starts a recording of the determined measured values for later evaluation

Performing an individual spot measurement without image

The individual spot measurement without image allows you to record several individual measuring points. To do so, please proceed as follows:

1. Repeatedly press the *On / off / measurement* button (3) on the appSensor or the *Refresh measured value* button (10) on the terminal device until you have logged all the required measured values.

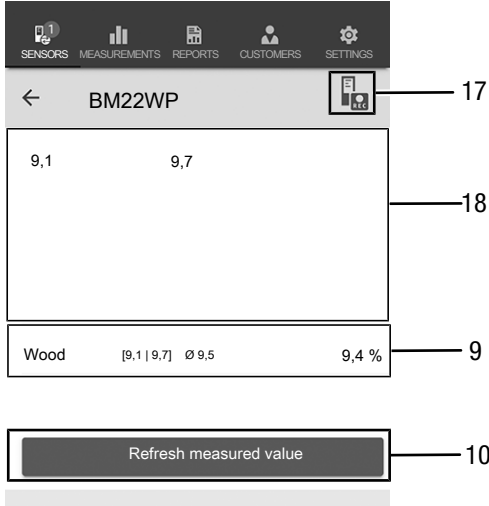

No.	Designation	Meaning
9	Numeric <i>value</i> display	Indicates the minimum, maximum and average values as well as the current moisture value of the selected material in per cent (material selection via sensor settings)
10	<i>Refresh measured value</i> button	Performs an individual measurement and refreshes the displayed values
17	<i>REC</i> button	Opens the context menu for sensors
18	Measurement series indication	Measured values: Indicates the measured values of the measurement series in per cent

Performing an individual spot measurement with image

If you have selected individual spot measurement with image, you will be prompted to choose whether you want to use a photo already saved in the mobile device's gallery or take a new one directly in the app. Choose an image section that best matches the measuring surface.

For measured value data logging please proceed as follows:

1. Tap the screen at the exact measuring location. The measured value will be displayed at this location.
2. You can also press the *On / off / measurement* button (3) on the appSensor.
 - ⇒ The measured value will be displayed in a specified grid on the background image. Pressing the *Shift measuring point* button (20) allows you to adjust the position of the measuring points. By pressing the *Shift measuring point* button (20) once more you can return to the measuring mode.

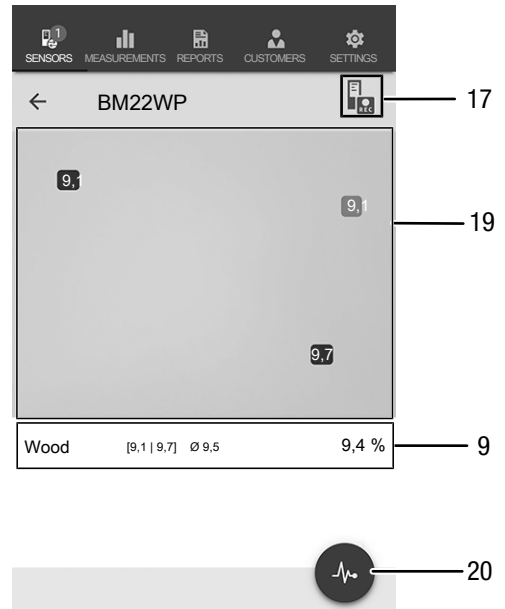

No.	Designation	Meaning
9	Numeric <i>value</i> display	Indicates the minimum, maximum and average values as well as the current moisture value of the selected material in per cent (material selection via sensor settings)
17	<i>REC</i> button	Opens the context menu for sensors
19	Measuring field indication	Indicates the image of the measuring field and the values measured at the measuring points
20	<i>Shift measuring point</i> button	Stops the measured value data logging and allows you to relocate the measuring points on the background image

Performing a matrix measurement without background image

In case of a matrix measurement an entire series of measuring points is captured using a grid the size of which has to be selected.

1. Always start a matrix measurement in the top left corner (1st row, 1st column).
 - ⇒ The grid field to be measured flashes.
2. Perform the measurement in the flashing grid field.
3. Confirm the measured value by pressing the *Measured value data logging* button (22). You can reset a logged value by pressing *UNDO* (23). You can skip the indicated grid field and continue with the measurement in the next by pressing the *SKIP* button (24).
 - ⇒ The displayed measurement grid (21) moves on to the next line.
4. Perform the next measurement at the given point.
5. Press *NEW COLUMN* (25) when you have completed the measurements of all lines in one column so as to move on to the next.

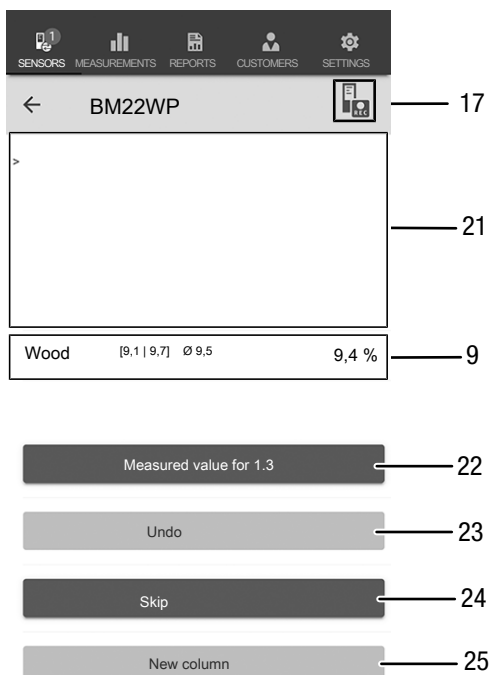

No.	Designation	Meaning
9	Numeric <i>value</i> display	Indicates the minimum, maximum and average values as well as the current moisture value of the selected material in per cent (material selection via sensor settings)
17	<i>REC</i> button	Opens the context menu for sensors
21	Measuring field with grid	Indicates the measurement grid of the measuring field (grid field to be measured flashes red)
22	<i>Measured value data logging</i> button	Saves the measured value for the flashing grid field

No.	Designation	Meaning
23	<i>UNDO</i> button	Deletes the saved measured value for the respective grid field
24	<i>SKIP</i> button	Skips the grid field flashing red and moves on to the next grid field
25	<i>NEW COLUMN</i> button	Starts a new column

Performing a matrix measurement with background image

If you select a matrix measurement with background image, you will be prompted to choose whether you want to use a photo already saved in the mobile device's gallery or take a new one directly in the app. Choose an image section that best matches the measuring surface. You will then reach the settings menu for the measurement grid (21).

1. Adjust the grid's number of columns and lines by use of the slider (26).
2. Confirm the settings for the grid by pressing *Use* (27).

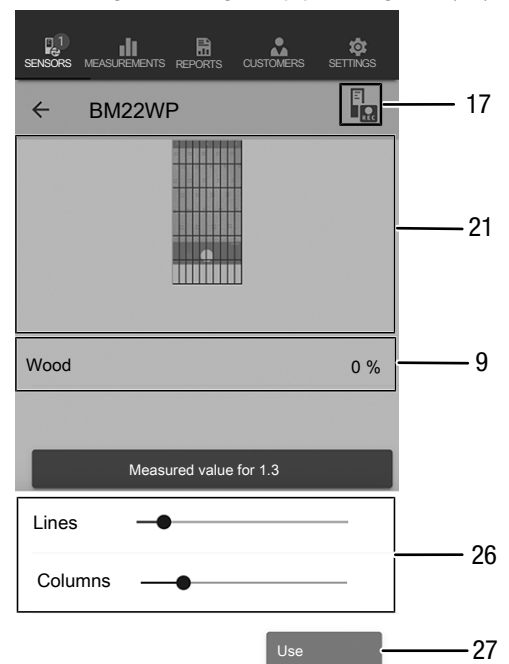

No.	Designation	Meaning
9	Numeric <i>value</i> display	Indicates the minimum, maximum and average values as well as the current moisture value of the selected material in per cent (material selection via sensor settings)
17	<i>REC</i> button	Opens the context menu for sensors
21	Measuring field with grid	Indicates the measurement grid of the measuring field
26	Slider	Changes the grid's number of columns and lines
27	<i>Use</i> button	Confirms the grid settings and leads to the measurement menu

Then start to carry out the measurements.

1. Always start a matrix measurement in the top left corner (1st row, 1st column).
 - ⇒ The grid field to be measured flashes.
2. Perform the measurement in the flashing grid field.
3. Confirm the measured value by pressing the *Measured value data logging* button (22). You can reset a logged value by pressing *UNDO* (23). You can skip the indicated grid field and continue with the measurement in the next by pressing the *SKIP* button (24).
 - ⇒ The displayed measurement grid (21) moves on to the next line.
4. Perform the next measurement at the given point.

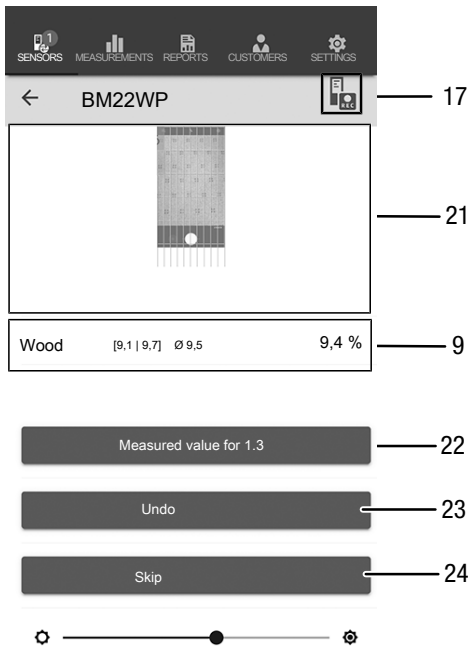

Info

By use of the slider you can optionally bring out either the background image or the grid.

Stopping a recording

Proceed as follows to stop recording the measured values:

1. Press the *REC* button (17).
 - ⇒ The context menu for sensors opens.
2. Press the *Stop recording* button (28).
 - ⇒ The context menu for saving the recording opens.
3. You can optionally save, discard or resume the measurement.

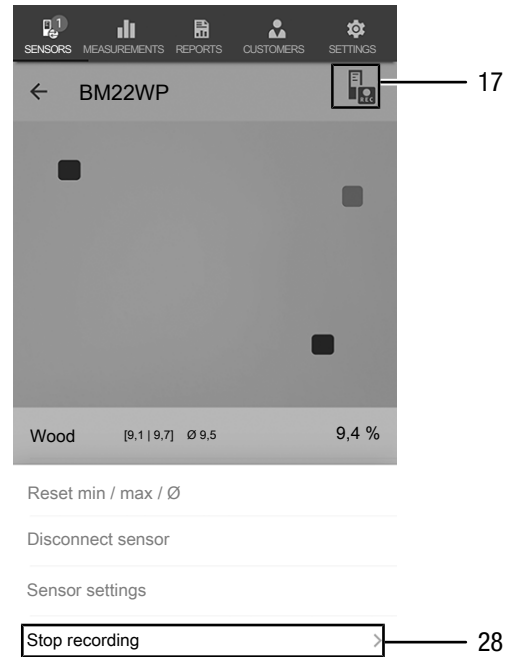

No.	Designation	Meaning
17	<i>REC</i> button	Opens the sensor settings menu.
28	<i>Stop recording</i> button	Stops the current recording of measured values. Opens the submenu for saving recordings.

No.	Designation	Meaning
9	Numeric <i>value</i> display	Indicates the minimum, maximum and average values as well as the current moisture value of the selected material in per cent (material selection via sensor settings)
17	<i>REC</i> button	Opens the context menu for sensors
21	Measuring field with grid	Indicates the measurement grid of the measuring field (grid field to be measured flashes red)
22	<i>Measured value data logging</i> button	Saves the measured value for the flashing grid field
23	<i>UNDO</i> button	Deletes the saved measured value for the respective grid field
24	<i>SKIP</i> button	Skips the grid field flashing red and moves on to the next grid field

Saving a recording

Proceed as follows to save the recorded measured values:

1. Press the *Save* button (29) to save the recorded measured values on the terminal device.
⇒ The input mask for logging the recorded data opens.
2. Enter all the data relevant for an unambiguous assignment, then save the recording.
⇒ The recording will be saved on the terminal device.

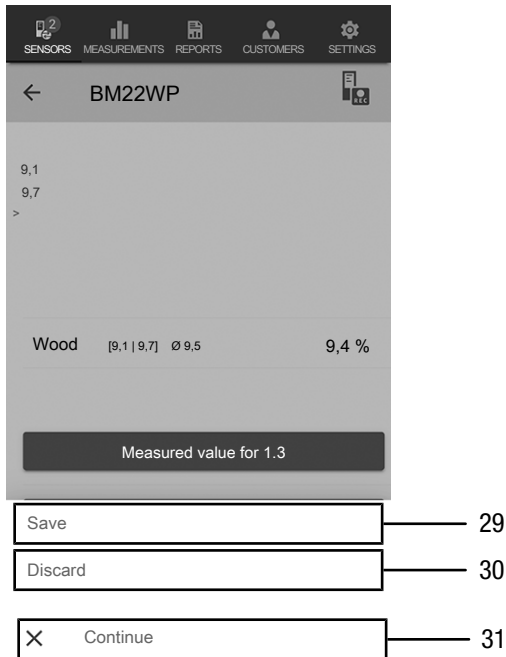

No.	Designation	Meaning
29	<i>Save</i> button	Stops the current recording of measured values. Opens the input mask for logging recording data.
30	<i>Discard</i> button	Stops the current recording of measured values. Discards the recorded measured values.
31	<i>Continue</i> button	Resumes the recording of the measured values without saving.

Analysing measurements

Proceed as follows to call up the saved measurements:

1. Press the *MEASUREMENTS* button (32).
⇒ An overview of already saved measurements will be displayed.
2. Press the *Display measurement* button (34) for the desired measurement to be indicated.
⇒ A context menu for the selected measurement opens.

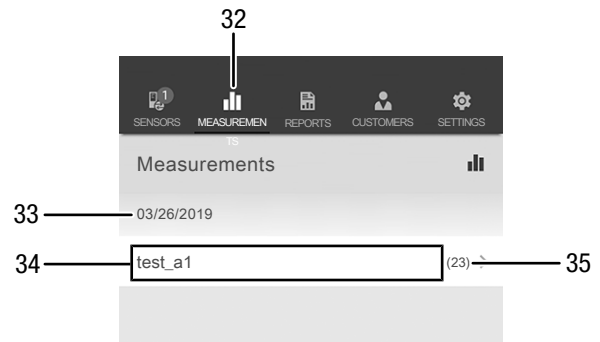

No.	Designation	Meaning
32	<i>MEASUREMENTS</i> button	Opens the overview of saved measurements.
33	Indication of the <i>date of the measurement</i>	Indicates the date on which the measurement was recorded.
34	<i>Display measurement</i> button	Opens the context menu for the selected measurement.
35	Indication of the <i>number of measured values</i>	Indicates the number of individual measured values constituting the saved measurement.

The following functions can be called up in the context menu of the selected measurement:

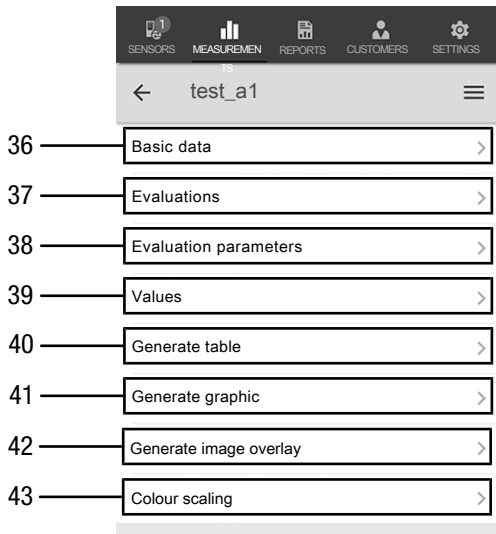

No.	Designation	Meaning
36	<i>Basic data</i> button	Opens an overview of the data saved for the measurement.
37	<i>Evaluations</i> button	Opens an overview of the evaluations generated for the measurement (graphics and tables).
38	<i>Evaluation parameters</i> button	Opens a menu to select and deselect individual evaluation parameters.
39	<i>Values</i> button	Opens a tabular overview of all logged values for the measurement.
40	<i>Generate table</i> button	Creates a table containing the logged values of the measurement and saves it as a *.CSV file.
41	<i>Generate graphic</i> button	Creates a graphic representation of the logged values and saves it as a *.PNG file.
42	<i>Generate image overlay</i> button	Combines a background image with the coloured representation of the measured moisture values.
43	<i>Colour scaling</i> button	Allows you to adjust the colour display of the measured moisture values.

Generating a report

The reports generated in the MultiMeasure Mobile app are short reports providing a fast and simple documentation. Proceed as follows to generate a new report:

1. Press the *REPORTS* button (44).
⇒ The reports overview opens.
2. Press the *New report* button (45) to create a new report.
⇒ An input mask for entering all the relevant information opens.
3. Enter the information via the input mask and save the data.

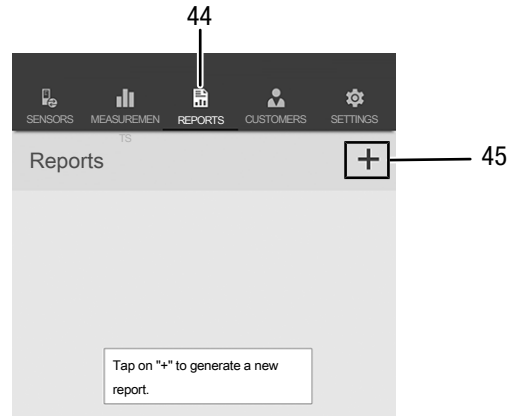

No.	Designation	Meaning
44	<i>REPORTS</i> button	Opens the overview of saved reports.
45	<i>New report</i> button	Creates a new report and opens the input mask.

Info

The customer can acknowledge the report directly in the integrated signature field.

Calling up a report

Proceed as follows to call up a created report:

1. Press the *REPORTS* button (44).
⇒ The reports overview opens.
2. Press the corresponding button (46) to display the desired report.
⇒ An input mask opens in which you can view and edit all the information.

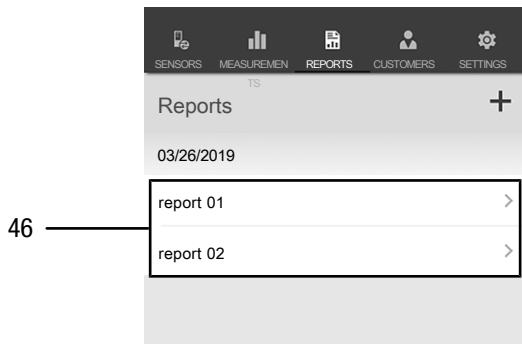

No.	Designation	Meaning
46	Display <i>REPORT</i> button	Opens the selected report.

Creating a new customer

Proceed as follows to create a new customer:

1. Press the *CUSTOMERS* button (47).
⇒ The customers overview opens.
2. Press the *New customer* button (48) to create a new customer.
⇒ An input mask for entering all the relevant information opens.
3. Enter the information via the input mask and save the data.
4. Alternatively, you can also import existing contacts from the phone book of the terminal device.

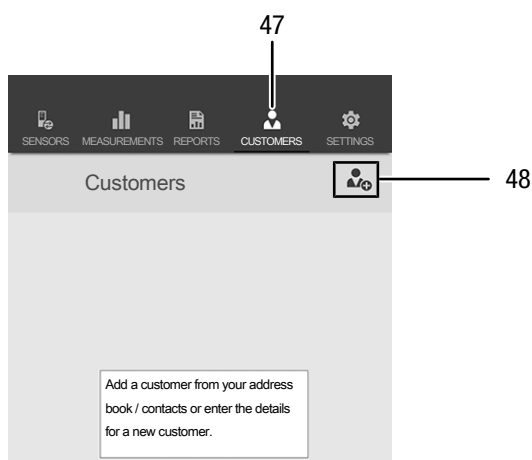

Info

You can perform a new measurement directly from the input mask.

Calling up customers

Proceed as follows to call up an already created customer:

1. Press the *CUSTOMERS* button (47).
⇒ The customers overview opens.
2. Press the corresponding button (49) to display the desired customer's details.
⇒ An input mask opens in which you can view and edit all the information for the selected customer as well as directly start a new measurement.
⇒ The *New customer* button (48) changes. In this menu it can be used to delete the selected customer data record.



App settings

Proceed as follows to make settings in the Trotec MultiMeasure Mobile app:

1. Press the *settings* button (50).
⇒ The settings menu opens.
2. Adjust the settings as required.

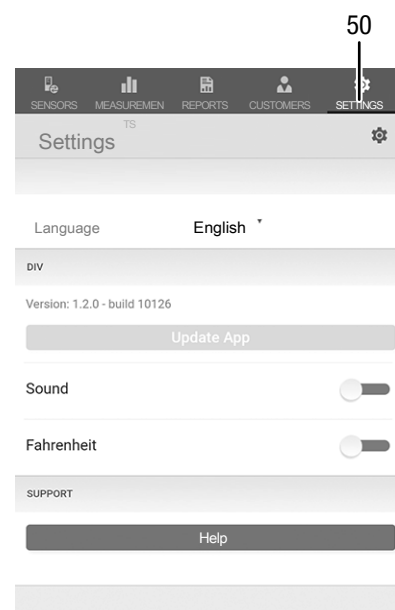

appSensor settings

Proceed as follows to adjust the settings for the appSensor:

1. Press the *Sensors* button (6).
⇒ A list of connected and available sensors will be displayed.
2. Select the line with the appSensor the settings of which you want do adjust and swipe right at the yellow marking.
3. Confirm your input.
⇒ The sensor menu opens.
4. Alternatively, you can press the *Sensors* button (6).
5. Press the *Menu* button (11).
⇒ The context menu opens.
6. Press the *Sensor settings* button (15).
⇒ The sensor menu opens.

Disconnecting an appSensor

Proceed as follows to disconnect an appSensor from the terminal device:

1. Press the *Sensors* button (6).
⇒ A list of connected and available sensors will be displayed.
2. Select the line with the appSensor to be disconnected and swipe left at the red marking.
3. Confirm your input.
⇒ The appSensor is now disconnected from the terminal device and can be switched off.
4. Alternatively, you can press the *Menu* button (11).
⇒ The context menu opens.
5. Press the *Disconnect sensor* button (14).
6. Confirm your input.
⇒ The appSensor is now disconnected from the terminal device and can be switched off.

Switching off an appSensor

Info

Always terminate the connection between appSensor and app before you switch off the appSensor.

Proceed as follows to switch off an appSensor:

1. Press and hold the *On / off / measurement* button (3) for approx. 3 seconds.
⇒ The LED (2) on the appSensor goes out.
⇒ The appSensor is switched off.
2. You may now exit the Trotec MultiMeasure Mobile app on the terminal device.

Measuring principle

The measuring device at hand serves for the rough determination of the material or wood moisture content according to the resistance measuring method. Fields of application are wood moisture measurements of sawn timber and firewood. Moreover, the measuring device can be used to detect the moisture in soft building materials such as gypsum or plaster.

The resistance measuring method is an indirect measurement method, since the moisture content of the measured material is deduced from the its conductivity.

Influencing variables suitable to change the conductivity, e.g. electrically conducting materials or dissolved salts, hence also have a direct influence on the determined measured values. Therefore, the displayed measured values can only be considered as indicator of the moisture content.

Notes on use regarding the wood moisture measurement:

For wood moisture measurement a calibration curve is stored in the device, which corresponds to the average of the relevant kinds of wood in Europe based on a wood temperature of 20 °C. Therefore, no further settings are required for a quick rough determination of the wood moisture content. If precise wood moisture values are required for other wood temperatures or with due regard of the type and bulk density of a certain timber, an additional control measurement applying the Darr procedure or else using a wood moisture measuring device with temperature comparison function and selection option for the specific wood type calibration is recommended.

- Always insert the measuring tips transverse to the wood fibre direction. The conductivity transverse to the wood fibre direction is lower than that in line with it.
- When selecting the measuring positions observe the following:
 - Always measure the material moisture at at least three different positions in order to achieve a sufficient accuracy by means of the arithmetic average.
 - Do not measure the face, because there are mainly dry areas.
 - Preferably do not measure at cracks, branches or resin pockets either.
- Oily and/or aqueous timber preservatives affect the measurement result.
- If possible, do not measure wood with a temperature below -5 °C. Too low wood temperatures distort the result of the measurement.
- Avoid static charge of the material to be measured due to friction. Static charge distorts the measurement result.

- With a wood moisture of less than 10 % RH, electrostatic forces may occur at the good to be measured. This can falsify the result of the measurement. Experience has shown that this occurs at the outlet of veneer drying plants. Remove the static charge by use of suitable grounding measures.
- The measurement's accuracy depends on the contact pressure of the measuring tips. The measuring tips must be connected to the wood in a way that the contact resistance is small as compared to the measuring resistance.

Notes on use regarding the material moisture measurement:

When assessing the measurement results one has to bear in mind that increased occurrences of soluble salts in the measured material can distort the result of the measurement. The more salts present, the higher the conductivity of the material and the higher will be the displayed measurement value.

Further observe disruptive influences due to electrically conducting substances:

If a construction material contains electrically conducting substances, it also has a lower resistance value, which then simulates high moisture values. Consequently, a too high measured value will be displayed.

From visual inspection it is not always apparent, whether there are any electrically conducting substances inside the construction material.

Some of the main error sources here are in particular reinforcements, metal laminations and conducting insulation such as slag in timber beam ceiling constructions. Especially in case of insulation materials with metal lamination, measured values are often misinterpreted during the resistance measurement. Quantitative conclusions about the moisture content of the mineral material to be measured can only be drawn by applying the Darr procedure or the CM method.

Maintenance and repair

Battery change

A battery change is required when the LED at the device flashes red or the device can no longer be switched on. See chapter Operation.

Exchanging measuring tips

The measuring tips can be exchanged as needed.

Further measuring tips are available as optional accessories. For further information please contact the customer service directly.

Exchange the measuring tips when they show signs of wear (e.g. oxidation, deformation, heavy, irremovable contaminations).

✓ Make sure that the device is switched off.

1. Remove the protective cap from the device.

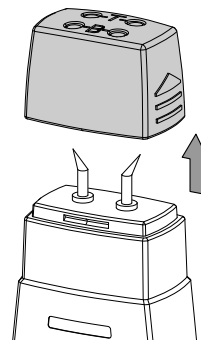

2. Detach the screwed-on measuring tips from the device.

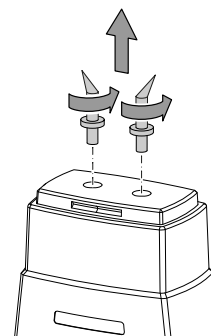

3. Screw the new measuring tips into the device.

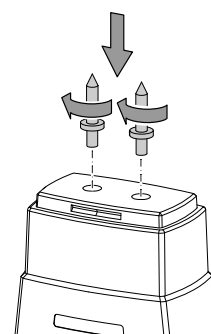

Cleaning

Clean the device with a soft, damp and lint-free cloth. Make sure that no moisture enters the housing. Do not use any sprays, solvents, alcohol-based cleaning agents or abrasive cleaners, but only clean water to moisten the cloth.

Repair

Do not modify the device or install any spare parts. For repairs or device testing, contact the manufacturer.

Errors and faults

Bluetooth connection is terminated or interrupted

- Check whether the LED at the appSensor flashes green. If so, briefly switch it off completely, then turn it back on. Establish a new connection to the terminal device.
- Check the battery voltage and insert new or freshly charged batteries, if required.
- Does the distance between appSensor and terminal device exceed the appSensor's radio range (see chapter *Technical data*) or are there any solid building parts (walls, pillars etc.) situated between appSensor and terminal device? Shorten the distance between the two devices and ensure a direct line of sight.

The sensor cannot be connected to the terminal device although it is displayed there.

- Check the Bluetooth settings of your terminal device. A possible reason for this could be special, manufacturer-specific settings relating to an improved location accuracy. Enable these settings, then try to establish a connection to the sensor again.

Further information and assistance regarding the used sensor type will be provided in the MultiMeasure Mobile app via the menu item Settings => *Help*. Selecting the menu item *Help* opens a link to the app's help page. You can open a drop-down menu with numerous support entries from the *Table of contents*. Optionally, you can also scroll through the entire help page and thoroughly acquaint yourself with the individual help topics.

Disposal

Always dispose of packing materials in an environmentally friendly manner and in accordance with the applicable local disposal regulations.



The icon with the crossed-out waste bin on waste electrical or electronic equipment is taken from Directive 2012/19/EU. It states that this device must not be disposed of with the household waste at the end of its life. You will find collection points for free return of waste electrical and electronic equipment in your vicinity. The addresses can be obtained from your municipality or local administration. You can also find out about other return options that apply for many EU countries on the website <https://hub.trotec.com/?id=45090>. Otherwise, please contact an official recycling centre for electronic and electrical equipment authorised for your country.

The separate collection of waste electrical and electronic equipment aims to enable the re-use, recycling and other forms of recovery of waste equipment as well as to prevent negative effects for the environment and human health caused by the disposal of hazardous substances potentially contained in the equipment.



In the European Union, batteries and accumulators must not be treated as domestic waste, but must be disposed of professionally in accordance with Directive 2006/66/EC of the European Parliament and of the Council of 6 September 2006 on batteries and accumulators. Please dispose of batteries and accumulators according to the relevant legal requirements.

Only for United Kingdom

According to Waste Electrical and Electronic Equipment Regulations 2013 (SI 2013/3113) (as amended) and the Waste Batteries and Accumulators Regulations 2009 (SI 2009/890) (as amended), devices that are no longer usable must be collected separately and disposed of in an environmentally friendly manner.

Declaration of conformity

We – Trotec GmbH – declare in sole responsibility that the product designated below was developed, constructed and produced in compliance with the requirements of the EU Radio Equipment Directive in the version 2014/53/EU.

Product model / Product: BM22WP
Product type: material moisture measuring device controlled via smartphone
Year of manufacture as of: 2019

Relevant EU directives:

- 2011/65/EU
- 2014/30/EU
- 2015/863/EU

Applied harmonised standards:

- EN 300 328 V2.2.2

Applied national standards and technical specifications:

- EN 301 489-1 Draft Version 2.2.0:2017-03
- EN 301 489-17 Draft Version 3.2.0:2017-03
- EN 61010-1:2010
- EN 61326-1:2013
- EN 62479:2010
- IEC 62321-3-1:2013
- IEC 62321-6:2015
- IEC 62321-7-1:2015
- IEC 62321-7-2:2017
- IEC 62321-8:2017

Manufacturer and name of the authorised representative of the technical documentation:

Trotec GmbH
Grebbener Straße 7, D-52525 Heinsberg
Phone: +49 2452 962-400
E-mail: info@trotec.de

Place and date of issue:
Heinsberg, 17.02.2023



Joachim Ludwig, Managing Director

Trotec GmbH

Grebener Str. 7
D-52525 Heinsberg

☎ +49 2452 962-400

☎ +49 2452 962-200

✉ info@trotec.com

www.trotec.com